

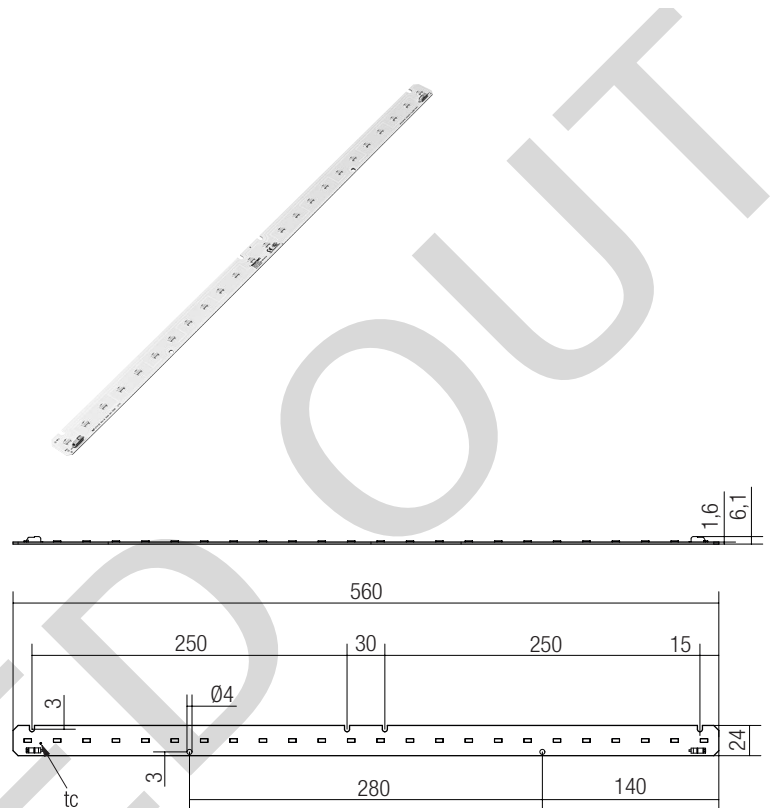

TALEXmodule STARK LLE-24-560-1300 CLASSIC STARK LLE

Product description

- Ideal for linear and panel lights
- Luminous flux range from 1,250 – 1,570 lm
- LED system solution with outstanding system efficacy up to 113 lm/W, consisting of linear LED module and dimmable LED control gear LCAI 040/0300
- Efficacy of the module up to 123 lm/W
- High colour rendering index CRI > 80
- Small colour tolerance MacAdam 3[°]
- Small luminous flux tolerances
- Colour temperatures 3,000, 4,000 and 6,500 K
- Perfectly uniform light, even if several LED modules are used together in a line
- Push terminals for quick and simple wiring of LED module to LED module
- Simple installation (e.g. screws)
- Long life-time: 50,000 hours
- 5-year guarantee



Technical data

Beam characteristic	120°
Ambient temperature t_a	-30 ... +45 °C
Typ. tp point	65 °C
Risk group (EN 62471:2008)	0
Type of protection	IP00

Ordering data

Type	Article number	Colour temperature	Packaging carton	Weight per pc.
TALEXmodule STARK-LLE-24-560-1300-830-CLA	28000157	3,000 K	240 pc(s).	0.046 kg
TALEXmodule STARK-LLE-24-560-1300-840-CLA	28000158	4,000 K	240 pc(s).	0.046 kg
TALEXmodule STARK-LLE-24-560-1300-865-CLA	89800380	6,500 K	75 pc(s).	0.045 kg



Standards, page 4

Colour temperatures and tolerances, page 7

Specific technical data

Type [®]	Photo-metric code	Typ. luminous flux at $t_p = 25\text{ °C}$ [®]	Typ. luminous flux at $t_p = 65\text{ °C}$ [®]	Typ. forward current [®] [®] [®]	Min. forward voltage at $t_p = 65\text{ °C}$	Max. forward voltage at $t_p = 25\text{ °C}$	Typ. power consumption at $t_p = 65\text{ °C}$ [®]	Efficacy of the module at $t_p = 25\text{ °C}$	Efficacy of the module at $t_p = 65\text{ °C}$	Efficacy of the system at $t_p = 65\text{ °C}$	Colour rendering index CRI	Energy classification
Operating mode HE at 300 mA												
STARK-LLE-24-560-1300-830-CLA	830/369	1,300 lm	1,250 lm	300 mA	32.8 V	39.5 V	10.7 W	118 lm/W	117 lm/W	109 lm/W	> 80	A+
STARK-LLE-24-560-1300-840-CLA	840/369	1,350 lm	1,300 lm	300 mA	32.8 V	39.5 V	10.7 W	123 lm/W	121 lm/W	113 lm/W	> 80	A+
STARK-LLE-24-560-1300-865-CLA	865/358	1,380 lm	1,310 lm	300 mA	30.0 V	42.0 V	10.6 W	125 lm/W	123 lm/W	114 lm/W	> 80	A+
Operating mode HO at 350 mA												
STARK-LLE-24-560-1300-830-CLA	830/369	1,510 lm	1,450 lm	350 mA	33.2 V	40.0 V	12.7 W	117 lm/W	114 lm/W	106 lm/W	> 80	A+
STARK-LLE-24-560-1300-840-CLA	840/369	1,570 lm	1,500 lm	350 mA	33.2 V	40.0 V	12.7 W	122 lm/W	118 lm/W	110 lm/W	> 80	A+
STARK-LLE-24-560-1300-865-CLA	865/358	1,550 lm	1,480 lm	350 mA	30.7 V	42.8 V	12.7 W	118 lm/W	116 lm/W	108 lm/W	> 80	A+

[®] Central measurement over the whole module.

[®] Tolerance range for optical and electrical data: ±10 %.

[®] Max. permissible repetitive peak current 3,000 and 4,000 K: 480 mA; 6,500 K: 600 mA.

[®] Max. permissible surge current 3,000 and 4,000 K: 1 A, duration max. 10 µs; 6,500 K: 0.8 A, duration max. 10 ms.

[®] HE ... high efficiency, HO ... high output.

Product description

- LINEAR COVER / ENDCAP for LLE 24
- Protection against direct touch for non-SELV applications
- Mounting COVER: Fast snap on mounting on to LLE 24 with clips or plastic washers
- Mounting ENDCAP: Fast snap on mounting (sheet thickness 0.5 – 1.0 mm), for drilling hole 4 mm
- High transmission: transparent 94 %, semi-transparent 87 %, diffuse 76 %
- Linear cover made of PMMA
- Endcap made of Polycarbonat
- Tolerances LINEAR COVER: ± 1 mm for 597 mm length (ends finished), + 20 mm for 1,200 / 1,500 / 1,600 / 1,800 mm length (ends raw)

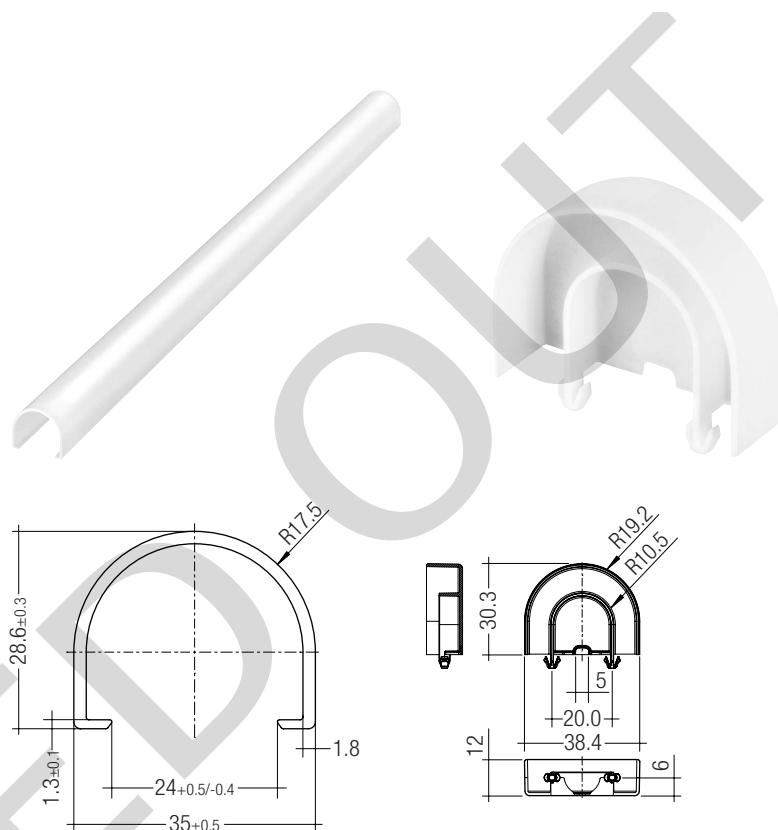
**Ordering data**

Type	Article number	Colour	Length	Packaging carton	Weight per pc.
LINEAR COVER SY Transparent 1600mm	28000338	Transparent	1,600 mm	12 pc(s).	0.272 kg
LINEAR COVER SY Frosted 1800mm	28000437	Semi-transparent	1,800 mm	12 pc(s).	0.308 kg
LINEAR COVER SY Frosted 1600mm	28000339	Semi-transparent	1,600 mm	12 pc(s).	0.272 kg
LINEAR COVER SY Frosted 1500mm	28000435	Semi-transparent	1,500 mm	12 pc(s).	0.244 kg
LINEAR COVER SY Frosted 1200mm	28000422	Semi-transparent	1,200 mm	12 pc(s).	0.205 kg
LINEAR COVER SY Frosted 597mm	28000340	Semi-transparent	597 mm	12 pc(s).	0.102 kg
LINEAR COVER SY Diffuse 1800mm	28000438	Diffuse	1,800 mm	12 pc(s).	0.308 kg
LINEAR COVER SY Diffuse 1600mm	28000341	Diffuse	1,600 mm	12 pc(s).	0.272 kg
LINEAR COVER SY Diffuse 1500mm	28000436	Diffuse	1,500 mm	12 pc(s).	0.257 kg
LINEAR COVER SY Diffuse 1200mm	28000434	Diffuse	1,200 mm	12 pc(s).	0.205 kg
LINEAR COVER SY Diffuse 597mm	28000342	Diffuse	597 mm	12 pc(s).	0.102 kg
ACL ENDCAP LLE24 PUSH-FIX	28001037	White	-	480 pc(s).	0.003 kg

Product description

- Linear lens for LLE 24
- Available in 60° and 90° light distribution
- Protection against direct touch for non-SELV applications
- Fast snap on mounting on to LLE 24 with clips or plastic washers
- High transmission: semi-transparent **tbd %**
- Linear lense made of PMMA
- Tolerances: ± 20 mm for 1,600 mm legth (ends raw)

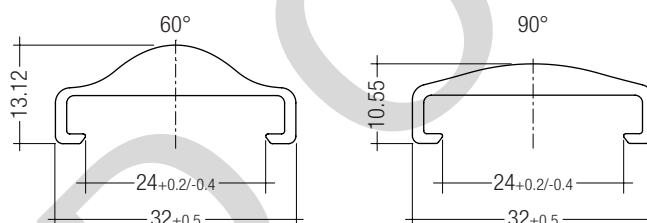
**Ordering data**

Type	Article number	Colour	Length	Packaging carton	Weight per pc.
ACL LINEAR LENS 24x1600mm 60°	28000953	Halbtransparent	1,600 mm	21 pc(s).	0.261 kg
ACL LINEAR LENS 24x1600mm 90°	28000955	Halbtransparent	1,600 mm	21 pc(s).	0.221 kg

Product description

- Clip for fixation of LED modules with 4.3 mm holes
- Fast snap on mounting (sheet thickness 0.5 – 1.0 mm)
- For drilling hole 4 mm
- Clip made of Polycarbonat

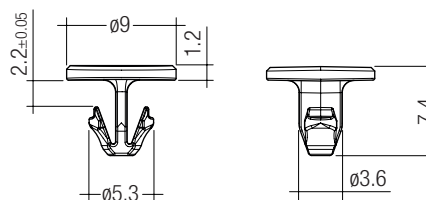
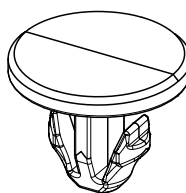
**Ordering data**

Type	Article number	Colour	Packaging bag [®]	Weight per pc.
ACL CLIP 4.3mm PUSH-FIX	28001036	White	500 pc(s).	0.001 kg

[®] Minimum sales quantity 500 pcs.

Standards

EN 62031
 EN 62471
 EN 61347-1
 EN 61547
 EN 55015

Photometric code

Key for photometric code, e. g. 830 / 369

1 st digit		2 nd + 3 rd digit	4 th digit	5 th digit	6 th digit	
Code	CRI	Colour temperature in Kelvin x 100	McAdams initial	McAdams after 25% of the life-time (max.6000h)	Lumen maintenance after 25% of the life-time (max.6000h)	
7	67 – 76				Code	Remaining lumen
8	77 – 86				7	≥ 70 %
9	87 – ≥90				8	≥ 80 %
				9	≥ 90 %	

Thermal design and heat sink

The rated life of TALEX products depends to a large extent on the temperature. If the permissible temperature limits are exceeded, the life of the TALEXmodule STARK LLE will be greatly reduced or the TALEXmodule STARK LLE may be destroyed.

tp point, ambient temperature and life-time

The temperature at tp reference point is crucial for the light output and life-time of a TALEX product.

For TALEXmodule STARK LLE a tp temperature of 65 °C has to be complied in order to achieve an optimum between heat sink requirements, light output and life-time.

Compliance with the maximum permissible reference temperature at the tc point must be checked under operating conditions in a thermally stable state. The maximum value must be determined under worst-case conditions for the relevant application.

The tc and tp temperature of LED modules from Tridonic are measured at the same reference point.

Mounting instruction

None of the components of the TALEXmodule STARK LLE (substrate, LED, electronic components etc.) may be exposed to tensile or compressive stresses.

Max. torque for fixing: 0.5 Nm.

The LED modules are mounted onto a heat sink with min. 4 screws per module. In order not to damage the modules only rounded head screws and an additional plastic flat washer should be used.



Chemical substance may harm the LED module. Chemical reactions could lead to colour shift, reduced luminous flux or a total failure of the module caused by corrosion of electrical connections.

Materials which are used in LED applications (e.g. sealings, adhesives) must not produce dissolver gas. They must not be condensation curing based, acetate curing based or contain sulfur, chlorine or phthalate. Avoid corrosive atmosphere during usage and storage.

**EOS/ESD safety guidelines**

The device / module contains components that are sensitive to electrostatic discharge and may only be installed in the factory and on site if appropriate EOS/ESD protection measures have been taken. No special measures need be taken for devices/modules with enclosed casings (contact with the pc board not possible), just normal installation practice. Please note the requirements set out in the document EOS / ESD guidelines (Guideline_EOS_ESD.pdf) at: <http://www.tridonic.com/esd-protection>

Heat sink values**TALEXmodule STARK LLE CLASSIC**

ta	tp	Forward current	R _{th, hs-a}	Cooling area
25 °C	65 °C	300 mA	self cooling	–
25 °C	65 °C	350 mA	self cooling	–
35 °C	65 °C	300 mA	self cooling	–
35 °C	65 °C	350 mA	4.9 K/W	135 cm ²
45 °C	65 °C	300 mA	4.9 K/W	135 cm ²
45 °C	65 °C	350 mA	2.3 K/W	279 cm ²

Notes

The actual cooling surface can differ because of the material, the structural shape, outside influences and the installation situation. Depending on the heat sink a heat conducting paste or heat conducting film might be necessary to keep the specified tp temperature.

Thermal behaviour

storage temperature	-40 ... +85 °C
operating temperature t_a	-30 ... +45 °C
t_c max. (at typ. current)	85 °C
t_p (at typ. current)	65 °C
max. humidity*	0 ... 80 %

* not condensating

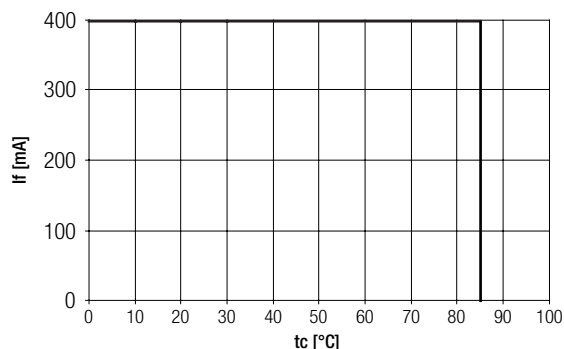

Life-time, lumen maintenance and failure rate

The light output of an LED Module decreases over the life-time, this is characterized with the L value.

L70 means that the LED module will give 70 % of its initial luminous flux. This value is always related to the number of operation hours and therefore defines the life-time of an LED module.

As the L value is a statistical value and the lumen maintenance may vary over the delivered LED modules.

The B value defines the amount of modules which are below the specific L value, e.g. L70B10 means 10 % of the LED modules are below 70 % of the initial luminous flux, respectively 90 % will be above 70 % of the initial value. In addition the percentage of failed modules (fatal failure) is characterized by the C value.

The F value is the combination of the B and C value. That means for F degradation and complete failures are considered, e.g. L70F10 means 10 % of the LED modules may fail or be below 70 % of the initial luminous flux.

Lumen maintenance for TALEXmodule STARK LLE-24-560-1300

Forward current	t_p temperature	L90 / F10		L80 / F50		L70 / F10		L70 / F50	
		L90 / F10	L90 / F50	L80 / F10	L80 / F50	L70 / F10	L70 / F50	L70 / F10	L70 / F50
300 mA	55 °C	15,000 h	22,000 h	31,000 h	46,000 h	49,000 h	> 60,000 h	> 60,000 h	> 60,000 h
	65 °C	12,000 h	18,000 h	25,000 h	38,000 h	40,000 h	> 60,000 h	> 60,000 h	> 60,000 h
	75 °C	10,000 h	15,000 h	21,000 h	31,000 h	33,000 h	49,000 h	49,000 h	49,000 h
350 mA	55 °C	12,000 h	18,000 h	26,000 h	39,000 h	42,000 h	> 60,000 h	> 60,000 h	> 60,000 h
	65 °C	10,000 h	15,000 h	21,000 h	32,000 h	34,000 h	51,000 h	51,000 h	51,000 h
	75 °C	8,000 h	12,000 h	17,000 h	26,000 h	28,000 h	41,000 h	41,000 h	41,000 h

Selection of the LED control gear

TALEXmodule STARK LLE can be operated either from SELV LED control gears or from LED control gears with LV output voltage.



TALEXmodule STARK LLE are basic isolated against ground and can be mounted directly on earthed metal parts of the luminaire also when used in conjunction with LED controlgear with LV output. In this case the light emitting side of the module has to be protected against direct touch (test finger). This is typically achieved by means of a non removable light distributor over the module.

Electrical supply/choice of LED control gear

TALEXmodule STARK LLE from Tridonic are not protected against overvoltages, overcurrents, overloads or short-circuit currents. Safe and reliable operation can only be guaranteed in conjunction with a LED control gear which complies with the relevant standards. The use of TALEXconverter from Tridonic in combination with TALEXmodule STARK LLE guarantees the necessary protection for safe and reliable operation.

If a LED control gear other than Tridonic TALEXconverter is used, it must provide the following protection:

- Short-circuit protection
- Overload protection
- Overtemperature protection



TALEXmodule STARK LLE must be supplied by a constant current LED control gear.

Operation with a constant voltage LED control gear will lead to an irreversible damage of the module.

Wrong polarity can damage the TALEXmodule STARK LLE.

With parallel wiring tolerance-related differences in output are possible (thermal stress of the module) and can cause differences in brightness. If one module fails, the remaining modules may be overloaded.

Wiring



Wiring examples

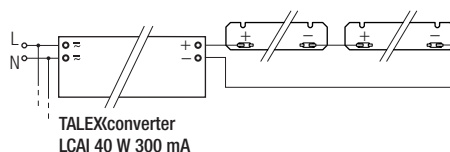

Wiring type and cross section

The wiring can be solid cable with a cross section of 0.2 to 0.75 mm². For the push-wire connection you have to strip the insulation (6–7 mm).

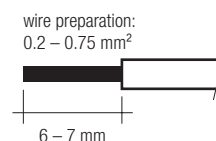

Inserting stranded wires / removing wires by lightly pressing on the push button.

Relative luminous flux

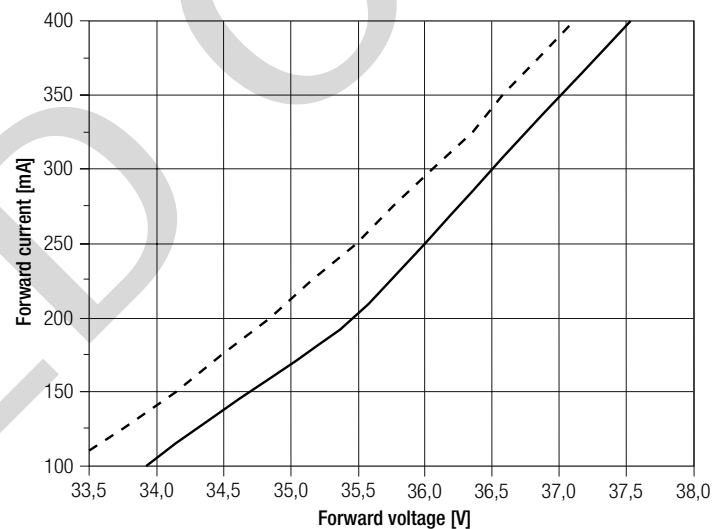
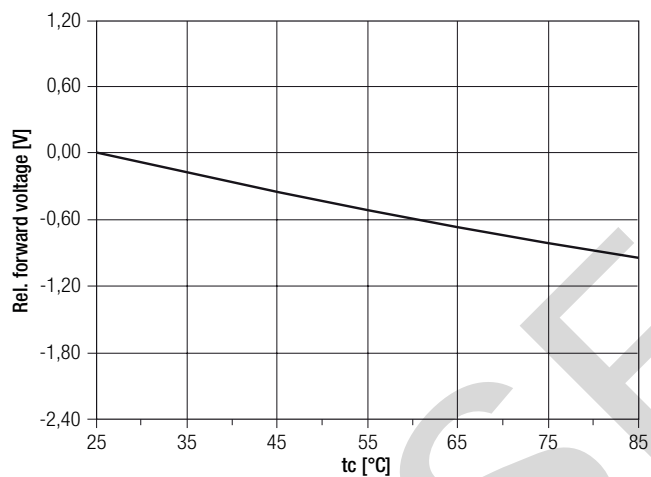
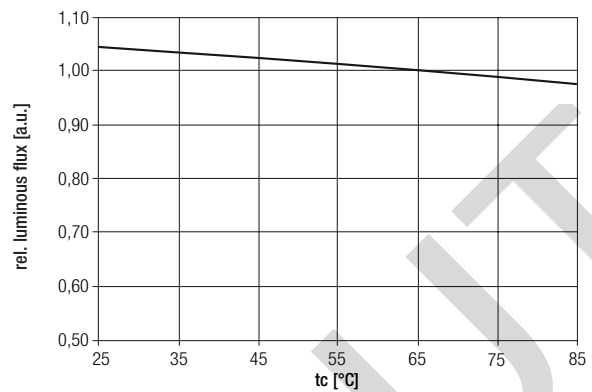
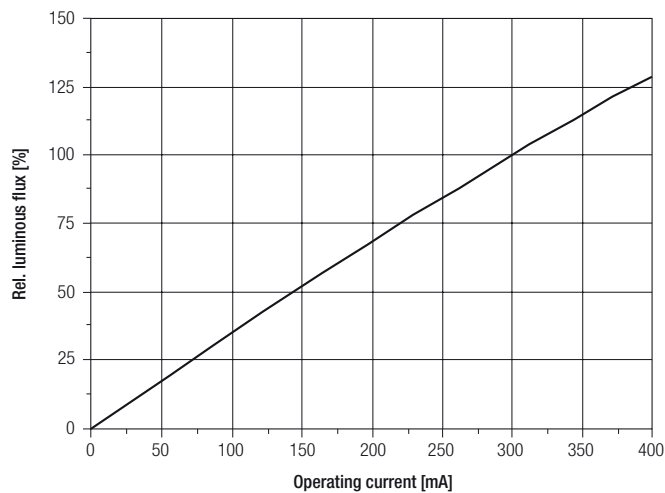

The diagrams are based on statistic values.
The real values can be different.

Optical characteristics TALEX(module STARK LLE)

The optical design of the TALEX(module STARK LLE) product line ensures optimum homogeneity for the light distribution.

Light distribution

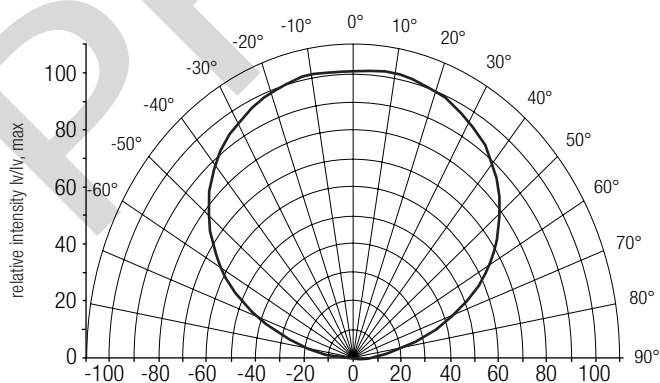

The colour temperature is measured integral over the complete module. The single LED light points can have deviations in the colour coordinates within MacAdam 7. To ensure an ideal mixture of colours and a homogenous light distribution a suitable optic (e. g. PMMA diffuser) and a sufficient spacing between module and optic (typ. 6 cm) should be used.

For further information see Design-in Guide, 3D data and photometric data on www.tridonic.com or on request.

Coordinates and tolerances according to CIE 1931

The specified colour coordinates are central measured by a current impulse with typical values of module and a duration of 100 ms.

The ambient temperature of the measurement is $t_a = 25\text{ }^\circ\text{C}$.

The measurement tolerance of the colour coordinates are ± 0.01 .

3,000 K

	x0	y0
Centre	0.4344	0.4032

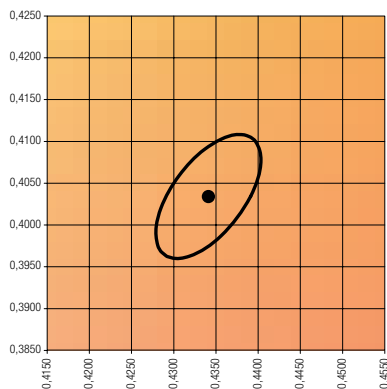

— MacAdam Ellipse: 3SDCM

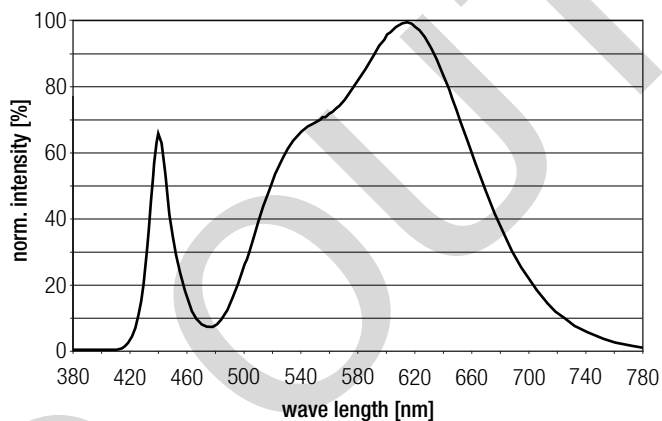

4,000 K

	x0	y0
Centre	0.3828	0.3803

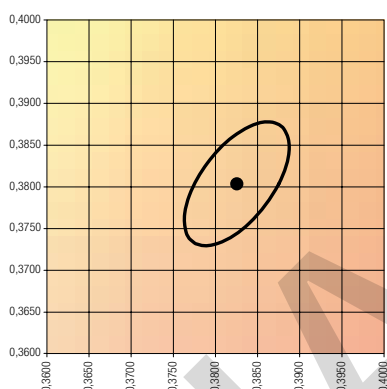

— MacAdam Ellipse: 3SDCM

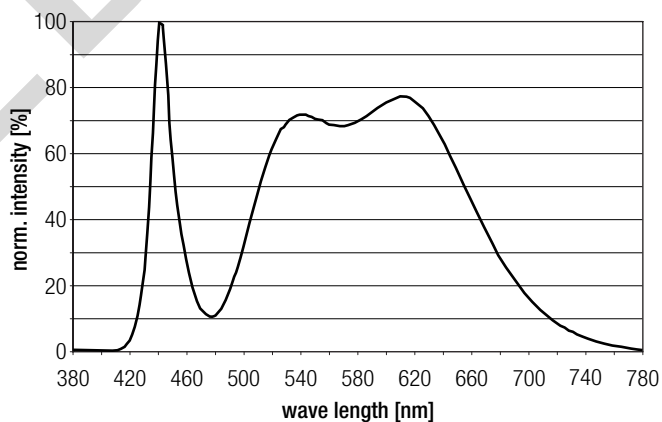

6,500 K

	x0	y0
Centre	0.3135	0.3284

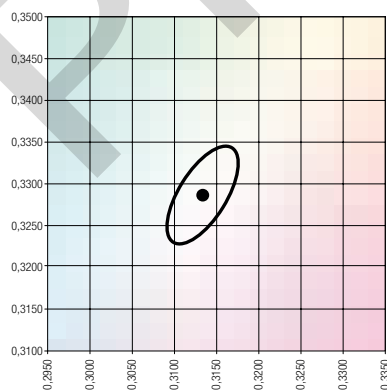

— MacAdam Ellipse: 3SDCM

