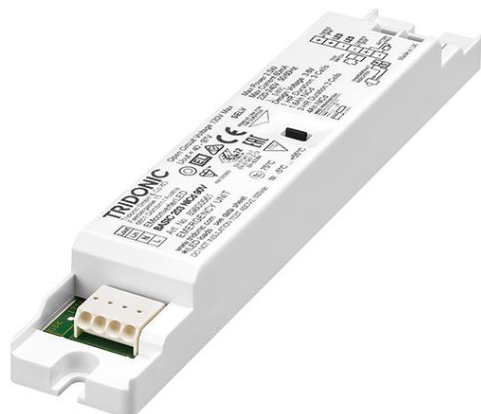

EM converterLED BASIC NiCd 90 V

BASIC version

New

**Product description**

- _ Emergency lighting LED Driver for manual testing
- _ For LED modules with a forward voltage of 40 – 97 V
- _ SELV for output voltage < 120 V DC
- _ Low profile casing (21 x 30 mm cross-section)
- _ For luminaire installation
- _ 5-year guarantee

Properties

- _ Non maintained operation
- _ 1 or 3 h rated duration
- _ Operating time selectable with plug (duration link)
- _ Compatible with all dimmable and non-dimmable constant current LED Driver (see data sheet, LED Driver compatibility)
- _ 3-pole technology: 2-pole LED module changeover and delayed power switching for the LED Driver
- _ Automatic shutdown of output if LED load is out of range
- _ Constant power output
- _ Maximum light output for all LED modules
- _ Electronic charge system
- _ Deep discharge protection
- _ Short-circuit-proof battery connection
- _ Polarity reversal protection for battery

Batteries

- _ High-temperature cells
- _ NiCd batteries
- _ D or Cs cells
- _ 4-year design life
- _ 1-year guarantee
- _ For battery compatibility refer to datasheet

Website

<http://www.tridonic.com/89800562>



EM converterLED BASIC NiCd 90 V

BASIC version

The complete data sheet for this product is available in the Downloads section.

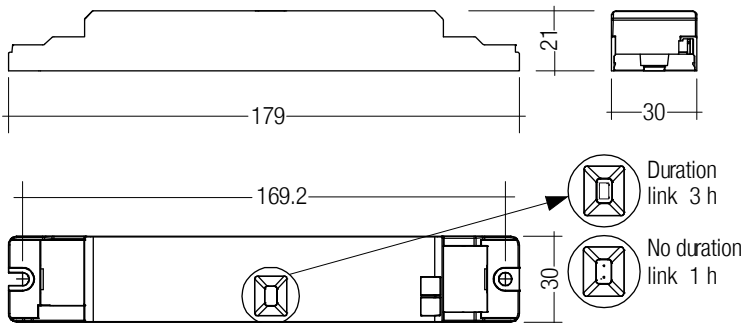

Note: Supply of control gear with duration link in 3 hours position. Remove duration link for duration of 1 h. Duration link must be set before battery and mains connection.

Ordering data

Type	Article number	Rated duration	Number of cells	Packaging, carton	Packaging, pallet	Weight per pc.
EM converterLED BASIC 204 NiCd 90V	89800562	1/3 h	4	10 pc(s).	1,600 pc(s).	0.065 kg

Technical data

Rated supply voltage	220 – 240 V
Mains frequency	50 / 60 Hz
Typ. λ (at 230 V, 50 Hz)	0.7
Forward voltage range LED module	40 – 97 V
Output current	See data sheet
Time to light	< 0.25 s from detection of emergency event
Overvoltage protection	320 V (for 48 h)
U-OUT	120 V
Battery charging time ^①	24 h
Ambient temperature t _a	-5 ... +55 °C
Max. casing temperature t _c	75 °C
Mains voltage changeover threshold	According to EN 60598-2-22
Type of protection	IP20
Dimensions L x W x H	179 x 30 x 21 mm

Approval marks



Standards

Acc. to EN 50172, Acc. to EN 60598-2-22, EN 61347-1, EN 61347-2-13, EN 61347-2-7, EN 55015, EN 61000-3-2, EN 61000-3-3, EN 61547, EN 60068-2-64, EN 60068-2-29, EN 60068-2-30, EN 62384

Specific technical data

Type	Rated duration	Typ. output power	Mains current in charging operation			Mains power in charging operation		
			Initial charge	Fast recharge	Trickle charge	Initial charge	Fast recharge	Trickle charge
EM converterLED BASIC 204 NiCd 90V	1 h	3.5 W	18 mA	18 mA	17 mA	2.5 W	2.5 W	2.0 W
EM converterLED BASIC 204 NiCd 90V	3 h	3.5 W	24 mA	24 mA	20 mA	3.8 W	3.8 W	2.5 W

① 16 h battery charging time for 2 h emergency lighting function according to AS 2293.